

SOLID LOCK INDOOR COB LED STRIP CONNECTOR

L: 13.5mm

W: 9.8mm

H: 4.2mm

SPECIFICATIONS

- Available PCB size: 8mm
- Pins: 2 Pin
- Typically Application: 2P SMD or COB IP20 NON WATERPROOF flexible led strip

APPLICATION

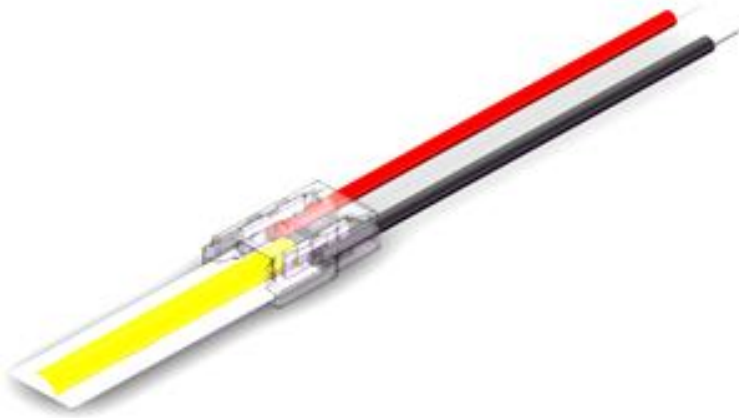
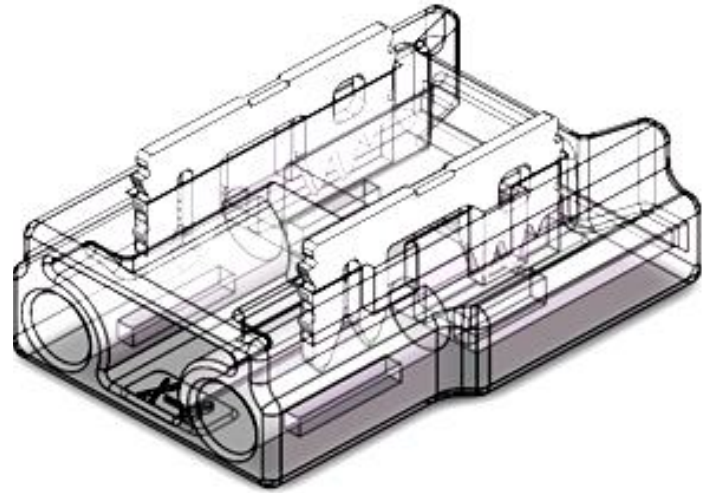

*1 = Custom length per FT.