

TRIAC/0-10V/1-10V/POTENTIOMETER/10V PWM

DEM SERIES indoor/outdoor drivers are highly efficient, stable with smooth dimming capability compatible with most TRIAC, ELV, MLV, 0-10V reverse and forward phase dimmers, and on/off switches. These drivers are factory derated which allows them to be loaded to maximum wattage capacity. The wet/dry housings are IP66 rated designed to fit most installations.



FEATURES

- Output constant voltage
- UL cUL listed, Class 2, Class P, Type HL, FCC, NEMA 4X, CE, RoHs
- Universal input, 110-277Vac
- Build in active PFC, typical power factor >0.95
- THD < 20% @ 120V Max. load
- High efficiency : up to 83%
- Load: 0.01-100%
- Short-circuit, over-temperature, over-load protection
- Full protection metal case, for dry, damp, wet location
- Flicker-free
- Suitable for LED lighting and moving sign applications



PRODUCT ADVANTAGES

- Dim-all: Triac/0-10V/1-10V/10V PWM/Potentiometer
- Switch to PWM or Voltage Reduce output
- Dimming effect: Voltage Reduce mode: 100%-0.01% dim, stepless dimming, flicker-free | PWM dim mode: 100-0.1% dim, flicker-free
- Triac dim mode: Forward phase & reverse phase, MLV, ELV dim
- Exclusive patent design of "Clamshell" junction box, low-profile logo
- Flexible wiring compartment to adjust the AC and DC wiring space
- Metal shell NEMA 4X for indoor and outdoor use; Wet, damp, and dry location
- Title 24 JA8 compliant
- Constant voltage type, fine tune of output voltage
- Super low loading request, works perfect at 0.01-100% load.
- 7 years warranty
- Dimming range: 100%-0.01% Ultra Deep Amplitude
- No Vpeak-peak during driver on/off and dimming, no harm to the LED for long-term using, and slow down the speed of lumen depreciation.
- Works with single channel CCT warm-dim LED strip/tape (2 wires).
- Switching different output mode, can be compatible with more different types of LED lamps
- Compatible with DC-DC design LED fixture, such as MR16, PAR, wall washer, linear lighting, LED strip/type

SPECIFICATIONS

Model	SL-TR-DEM60W-12V	SL-TR-DEM60W-24V	SL-TR-DEM60W-36V	SL-TR-DEM60W-48V	
Certificates	UL, cUL listed, Class 2 unit, Type HL rated, FCC NEMA 4X				
Output	DC Voltage	12V	24V	36V	48V
	Rated Current	5A	2.5A	1.66A	1.25A
	Rated Power	60W	60W	60W	60W
	Voltage Tolerance	±0.5V			
	Voltage Regulation	±0.5V			
	Load Regulation	±1% +1%			
Input	Voltage Range	110-277VAC			
	Frequency Range	47-63Hz			
	Power Factor (Typ.) @ full load	0.99@120VAC 0.95@277VAC			
	THD (Typ.) @ full load	<20% @120VAC &277VAC			
	Efficiency (Typ.) @ full load	81% @120Vac, 83%@277Vac 79%			
	AC Current (Max.	0.9A@110Vac			
	Inrush Current (Typ.)	14A, 50%, 780us @120Vac 15A, 50%, 660us @277Vac			
Leakage current	<0.50mA				
Protection	Short Circuit	Hiccup mode, recovers automatically after fault condition is removed.			
	Over Loading	≤120% Hiccup mode, recovers automatically after fault condition is removed			
	Over temperature	100°C±10°C shut down o/p voltage, automatically recover after cooling.			
Environment	Working TEMP.	-40~+60°C (see below derating curve)			
	Over Loading	20~90%RH, non-condensing			
	Over temperature	-40~+80°C, 10~95%RH			
	Over temperature	±0.03%/°C (0~50°C)			
Safety & EMC	Safety standards	UL8750+UL1310			
	Withstand voltage	I/P-O/P:1.88KVAC			
	Isolation resistance	I/P-O/P:100MΩ/500VDC/25°C/70%RH			
	EMC EMISSION	FCC Part 15 B			
Others	Net. Weight	1.0Kg			
	Size	226.5*117.5*42.5mm (L*W*H)			
	packing	10PCS/CTN,Packing size:275*255*250mm 385*335*200mm 20PCS/CTN			
Notes	1. All parameters if NOT specially mentioned are measured at 120VAC input , rated load and 25°Cof ambient temperature. 2. To extend the driver's using life ,please reduce the loading at lower input voltage.				

DERATING CURVE

To extend their life, please refer to the Derating Curve and derate according to the temperature.

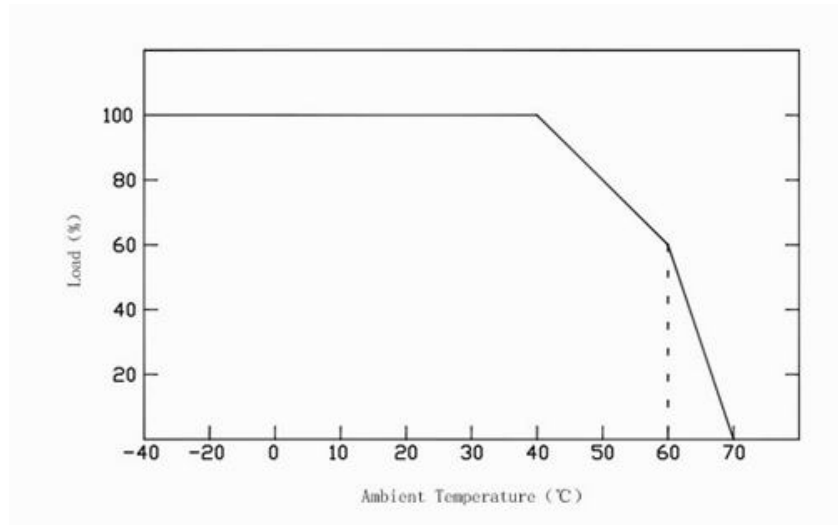

MECHANICAL SPECIFICATION

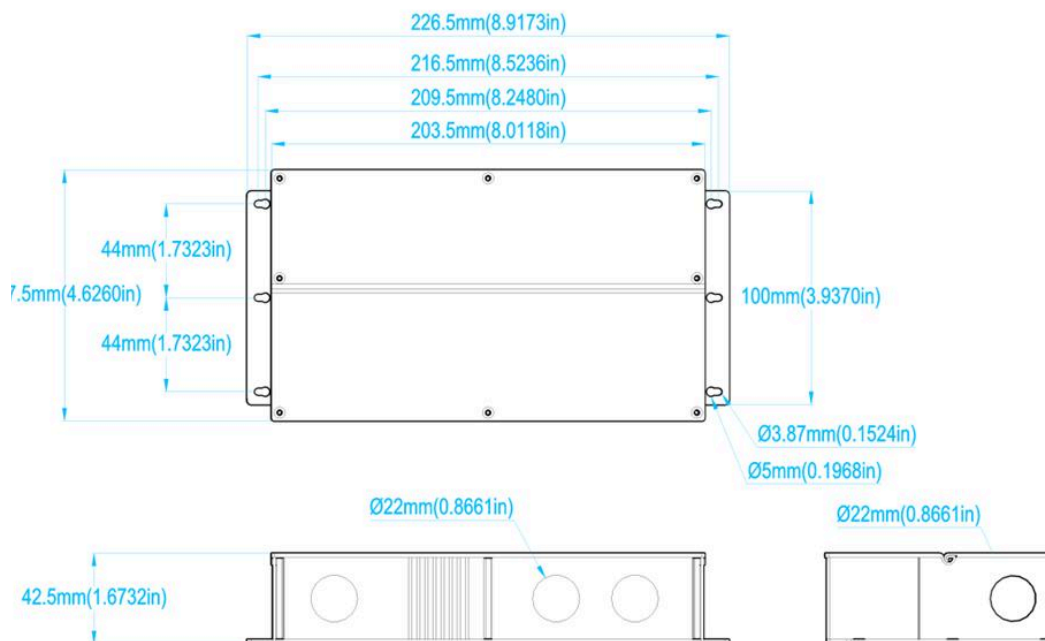

- Input wire Black and White to be connected to AC L and N ,Green wire go ground,
- Output wire Red to LED Positive side (+) , Black to LED Negative side (-).
- Dimming cable DIM (+) Purple to 0/1-10V dimmer signal(+) ,DIM (-) Pink to 0/1-10V dimmer signal (-)
- Please make sure your connect these correctly otherwise your product will not function correctly and could be damaged.

Note: Any other requests we can customized.

CONNECTING DIAGRAM

Using TRIAC/Phase cut dimming

1. The Pulse-Width Modulation (PWM) of output voltage can be adjusted through input terminal of the AC phase line(L) by connection a phase /Triac dimmer of lighting system.
2. Work with forward phase /leading edge ,MLV and reverse phase /trailing edge ,ELV,TRIAC dimmers.
3. Please try to use dimmers with power at least 1.5 times as the output power of the driver.

Using Triac MLV wiring diagram

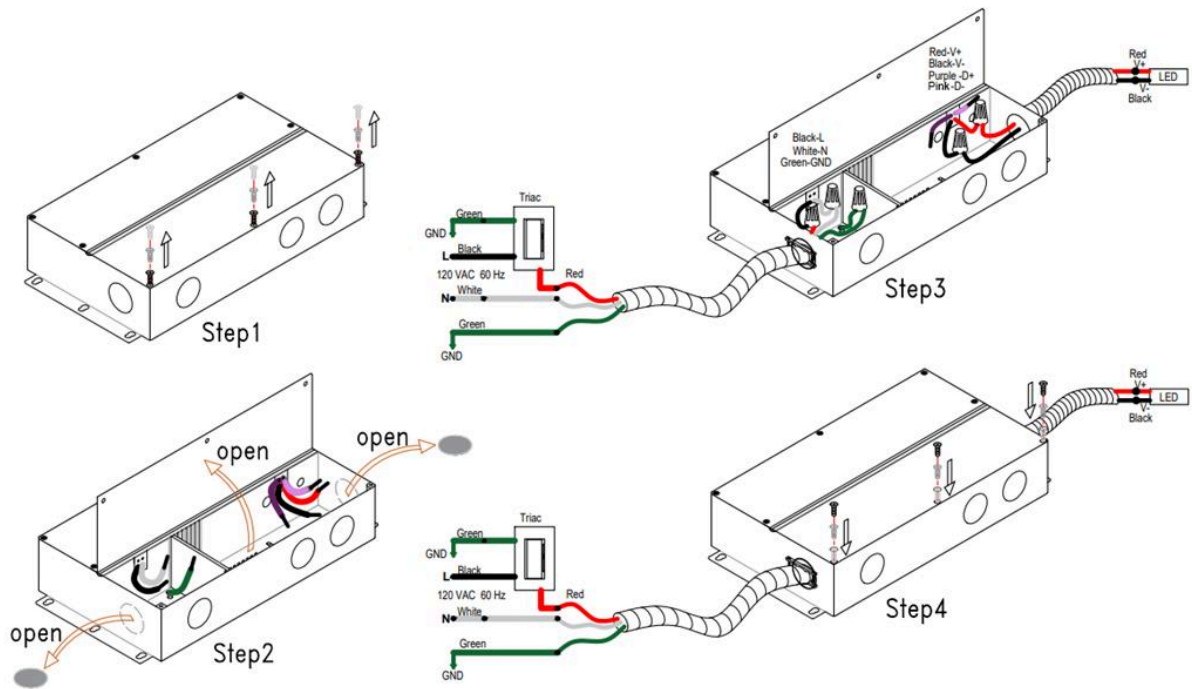

Using Triac ELV wiring diagram

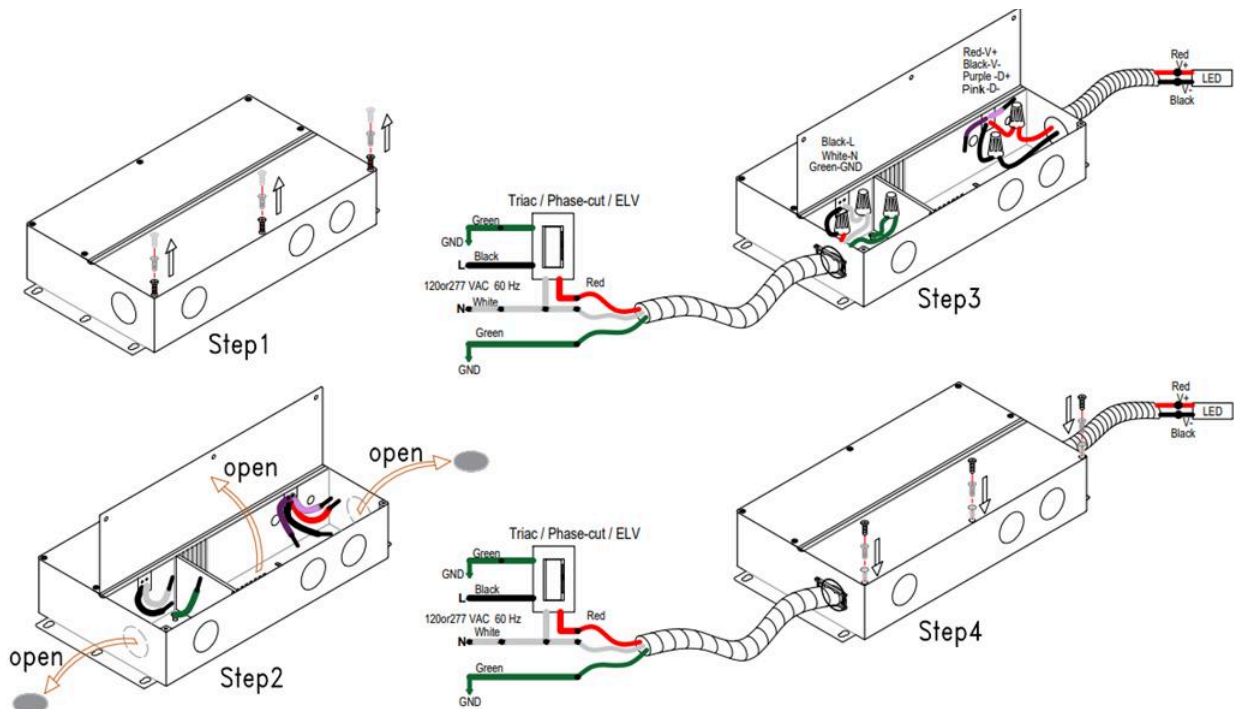

CONNECTING DIAGRAM

Using 0-10/1-10V dimming (The power supply does not pass through the dimmer)

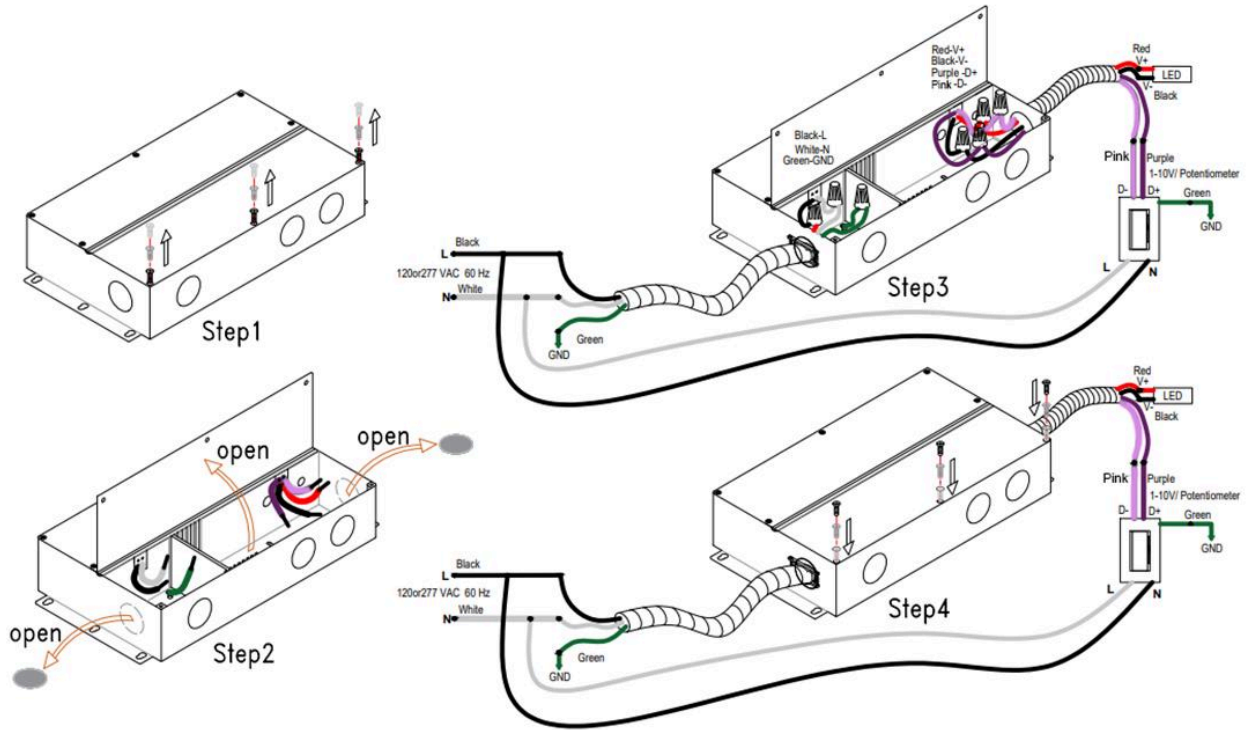

Using 0-10/1-10V dimming(Power supply through dimmer switch)

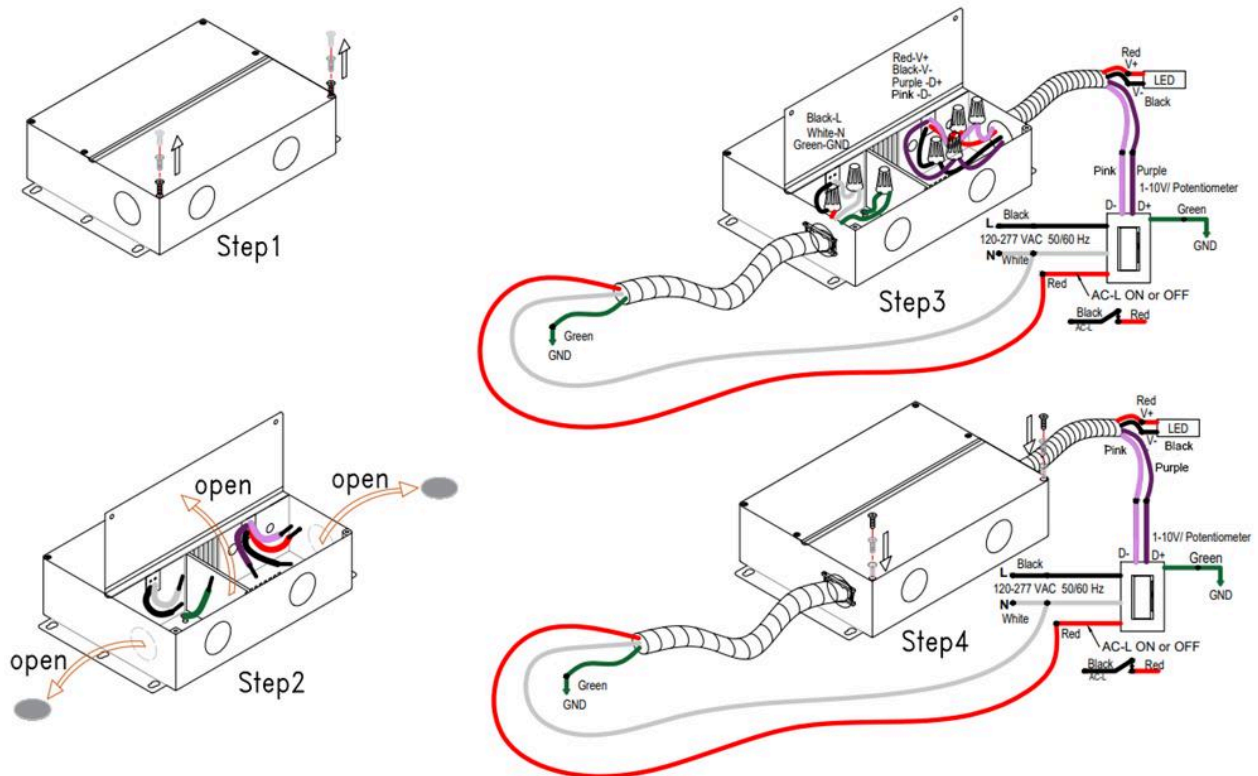

CONNECTING DIAGRAM

Using 0-10/1-10V dimming(The dimmer is not connected to high voltage)

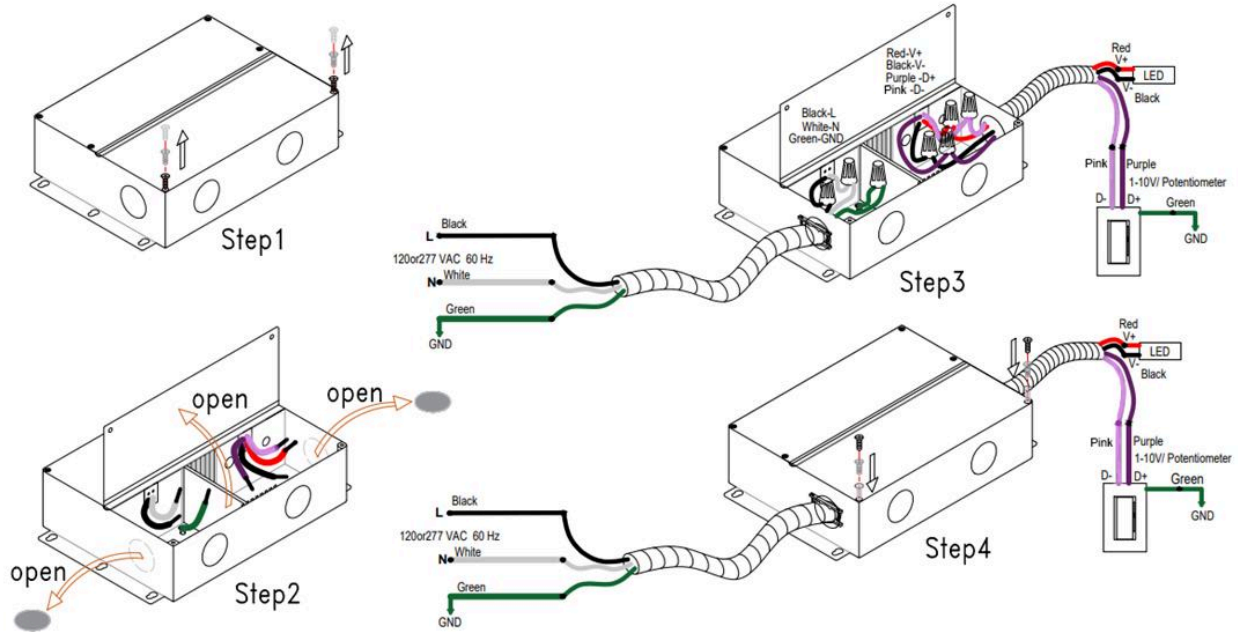

The topology

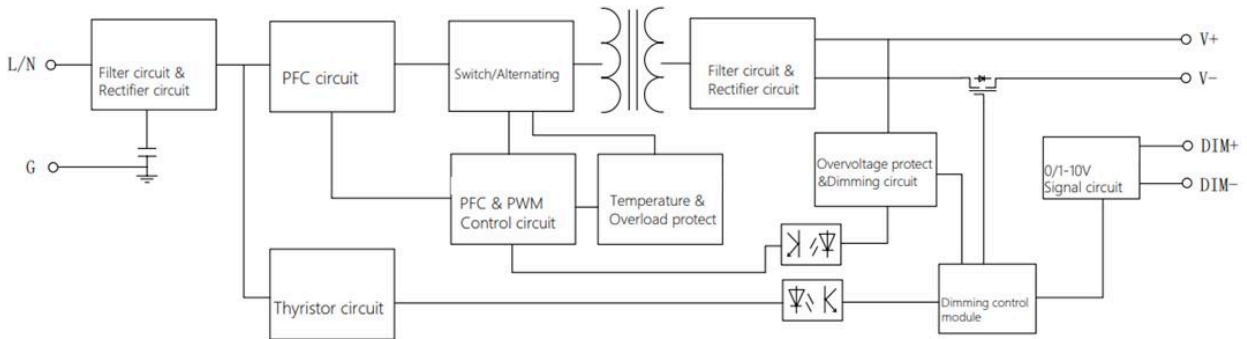

PFC load graph

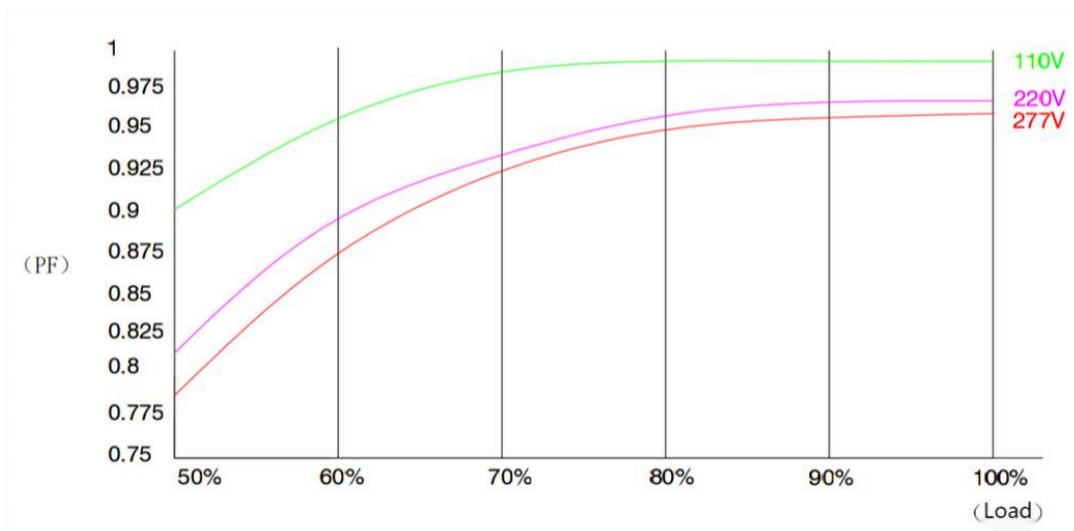

CONNECTING DIAGRAM

PWM dimming curve

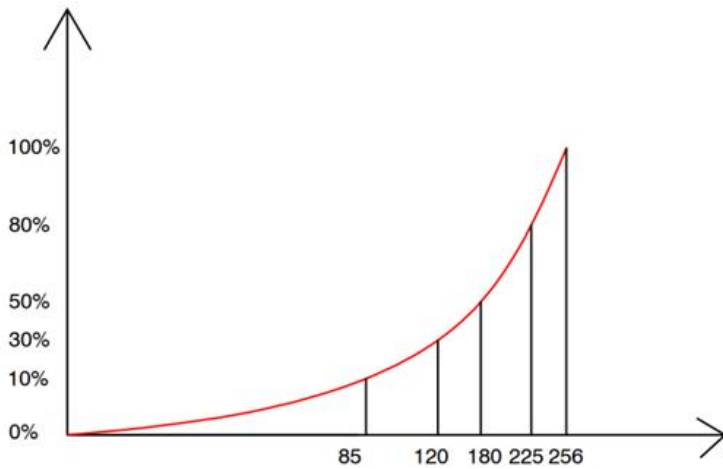

VR dimming curve

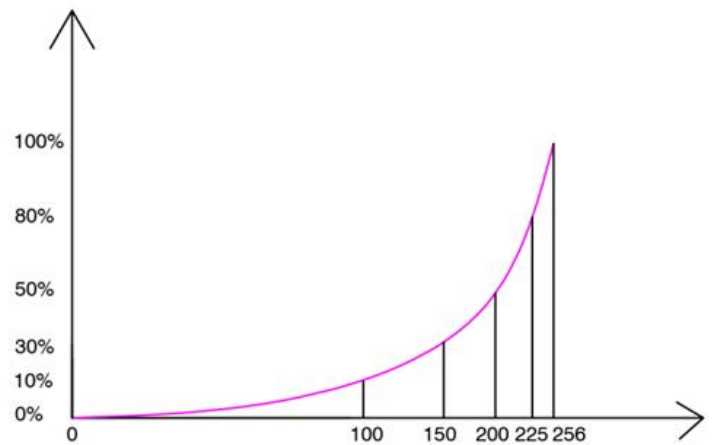

Power supply operating temperature and life curve

(Unit: hour)

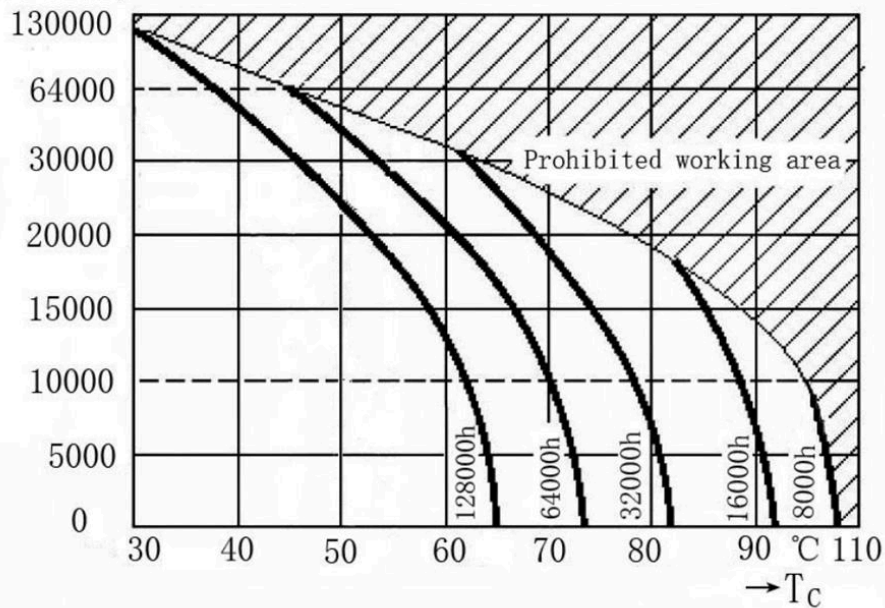

Instruction:

1. This driver should be installed by qualified and professional person;
2. Please make sure the driver is installed with adequate ventilation around it to allow for heat dissipation.
3. Ensure that wiring is correct before test in order to avoid light and power supply damage;